

CUSTOMER REFERENCE DRAWING

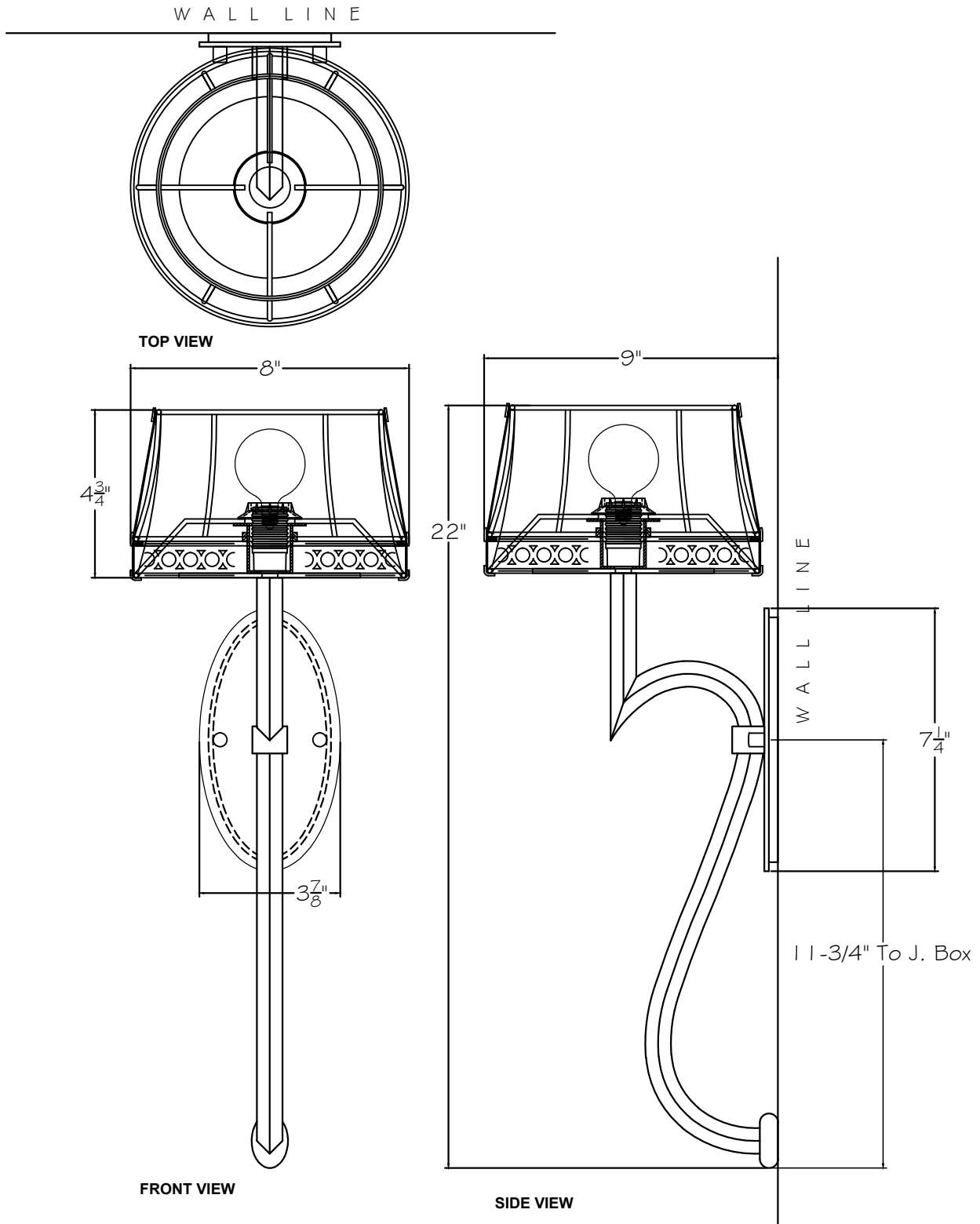

THUMBNAIL IMAGES OF STYLE OPTIONS:

-1ST SILVER  TAPERED SHADE	-2ST GOLD  TAPERED SHADE	-SF41 SILVER  WHITE SHADE	-SF42 SILVER  BLACK SHADE	-SF33 GOLD  BEIGE SHADE	-SF34 GOLD  BLACK SHADE
---	---	--	---	--	--

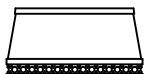
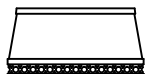
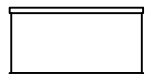
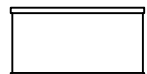
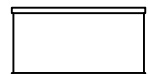
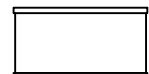

This drawing, specifications and the product depicted are the exclusive property of Fine Art Handcrafted Lighting®. In compliance with US copyright and patent requirements, notice is hereby given that this document and the product depicted shall not be copied, altered or used in any manner without the expressed written consent of Fine Art Handcrafted Lighting®.

www.finearthl.com

Tel:(305) 821-3850
FINE ART LAMPS®

Fax:(305) 513-5736

STYLE NUMBER:

784650

DATE:

4/17/2020