

CUSTOMER REFERENCE DRAWING

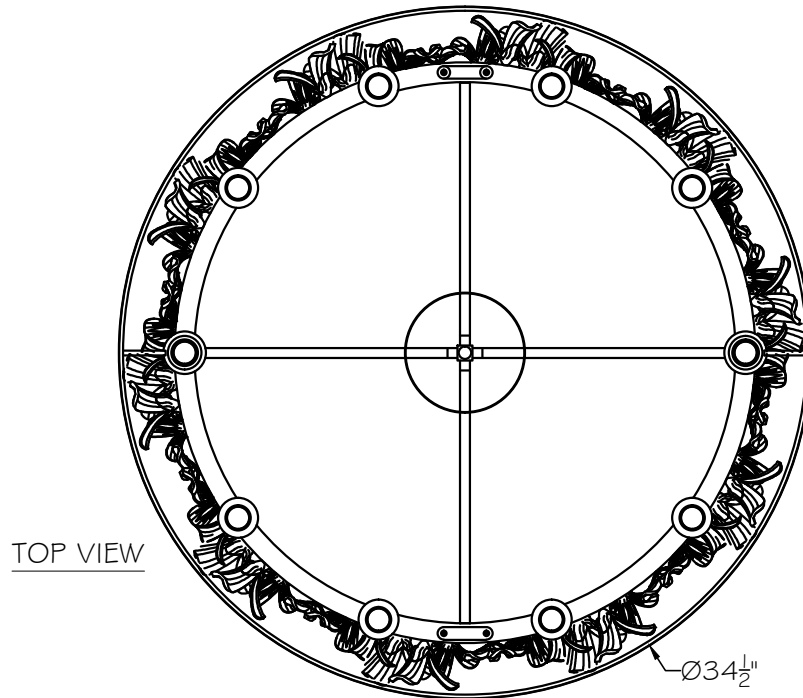

TOP VIEW

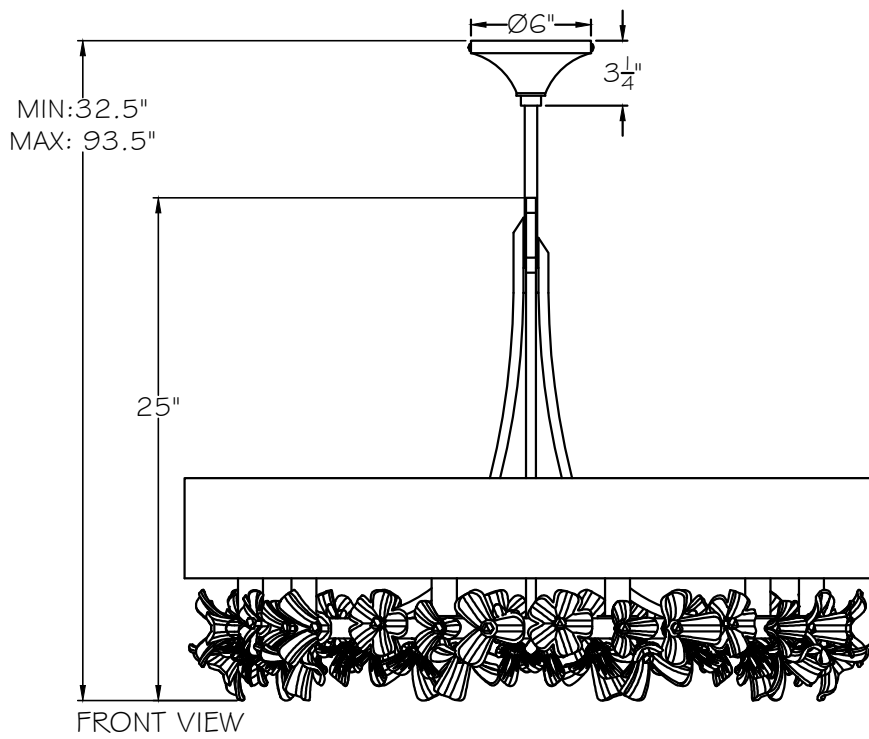

FRONT VIEW

THUMBNAIL IMAGES OF STYLE OPTIONS:

- 1 SILVER / NO SHADE
- 2 GOLD / NO SHADE
- 3 WHITE GESSO / NO SHADE

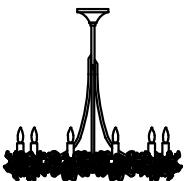

- 11 SILVER / WHITE SHADE
- 12 SILVER / CHAMPAGNE SHADE
- 13 SILVER / BLACK SHADE
- 21 GOLD / WHITE SHADE
- 22 GOLD / CHAMPAGNE SHADE
- 23 GOLD / BLACK SHADE
- 31 WHITE GESSO / WHITE SHADE
- 32 WHITE GESSO / CHAMP. SHDE

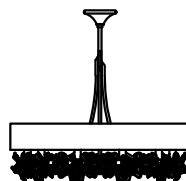

This drawing, specifications and the product depicted are the exclusive property of Fine Art Handcrafted Lighting®. In compliance with US copyright and patent requirements, notice is hereby given that this document and the product depicted shall not be copied, altered or used in any manner without the expressed written consent of Fine Art Handcrafted Lighting®.

www.finearthl.com

Tel:(305) 821-3850
FINE ART LAMPS®

Fax:(305) 513-5736

STYLE NUMBER:

915240

DATE:

8/26/20

CRYSTAL REFERENCE DRAWING

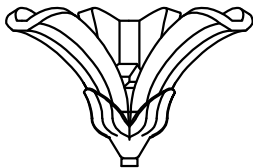

(X20)
CRYSTAL TALL CLUSTER

(A) GREEN STEM



(X10)
CRYSTAL FLAT CLUSTER

(B) ORANGE STEM



(X30)
METAL CLUSTER
(WITH CUTOUTS)

(C) YELLOW STEM

MOUNTING FIXTURE TO THE WALL:

1. REFERENCE ABOVE TABLE FOR FLOWER TYPES AND STEM COLOR CODE.
2. SEE PAGE 2 FOR ORDER OF PARTS FOR ASSEMBLY

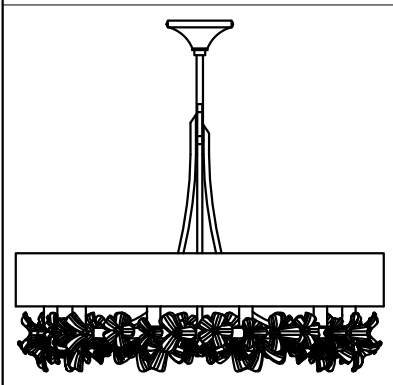
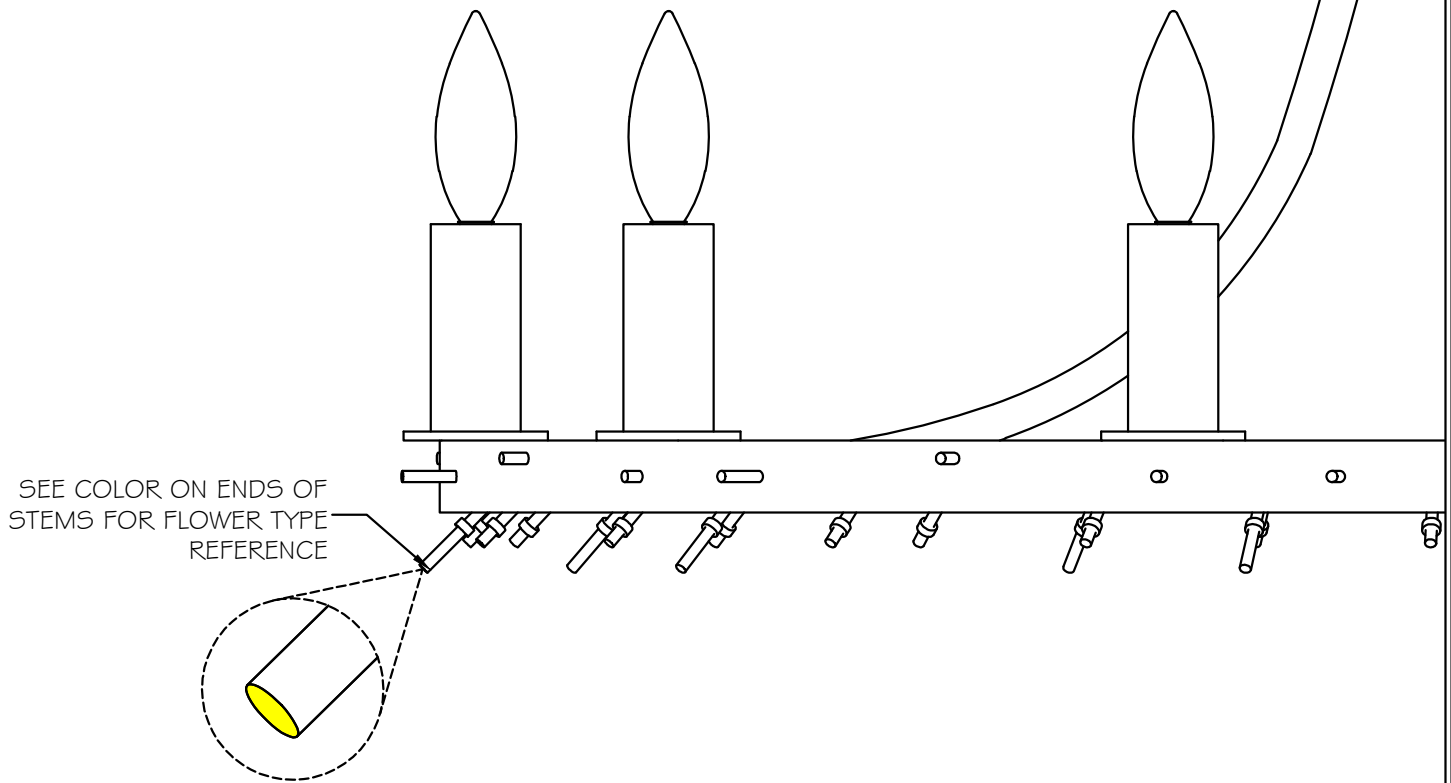

STYLE(S) #: 915240-1 -2 -11 -22 -13 -23

**FINE
ART**
HANDCRAFTED LIGHTING

This drawing, specifications and the product depicted are the exclusive property of Fine Art Handcrafted Lighting®. In compliance with US copyright and patent requirements, notice is hereby given that this document and the product depicted shall not be copied, altered or used in any manner without the expressed written consent of Fine Art Handcrafted Lighting®.

www.finearthl.com

Tel:(305) 821-3850
FINE ART LAMPS®

Fax:(305) 513-5736

INSTRUCTION #:

00791438

SHEET

1 / 2

CRYSTAL REFERENCE DRAWING

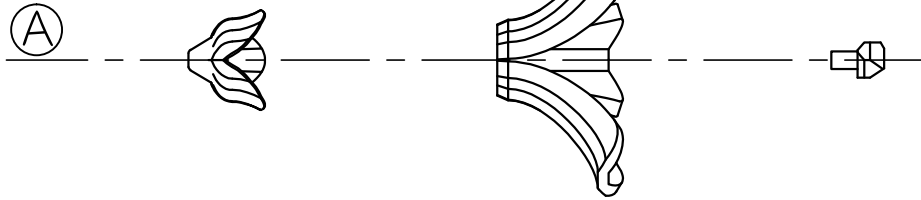

#:00700330 Q:20
METAL CUP #1

#:00301202 Q:20
CRYSTAL CLUSTER #1

#:00700329 Q:20
METAL FINIAL

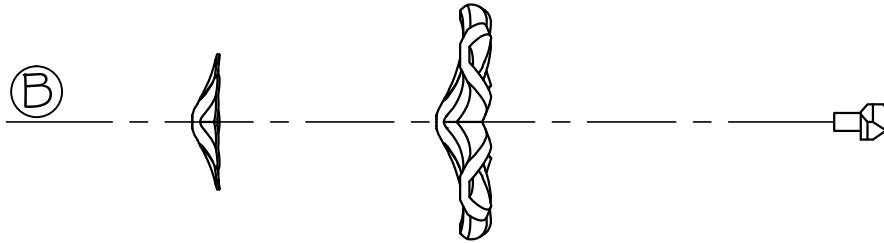

#:00700328 Q:10
METAL CUP #2

#:00301203 Q:10
CRYSTAL CLUSTER #2

#:00700329 Q:10
METAL FINIAL

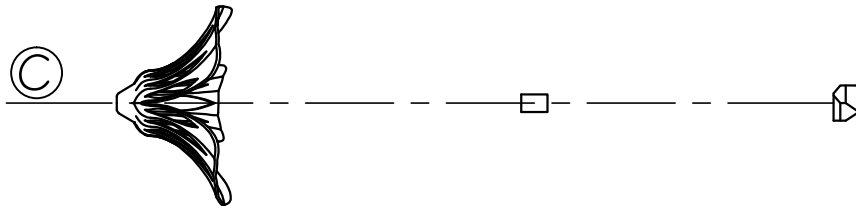

#:00700321 Q:30
PETALS METAL CUT

#:00204536 Q:30
STANDOFF

#:00301201 Q:30
CRYSTAL FINIAL

STYLE(S) #: 915240-1 -2 -11 -22 -13 -23



This drawing, specifications and the product depicted are the exclusive property of Fine Art Handcrafted Lighting®. In compliance with US copyright and patent requirements, notice is hereby given that this document and the product depicted shall not be copied, altered or used in any manner without the expressed written consent of Fine Art Handcrafted Lighting®.

www.finearthl.com

Tel:(305) 821-3850
FINE ART LAMPS®

Fax:(305) 513-5736

INSTRUCTION #:

00791438

SHEET

2 / 2